



 **VERSICO**  
**SUNPATH**  
TUBULAR SKYLIGHT 





## SunPath™ Tubular Daylighting Device (TDD)

Versico's SunPath TDD is a perfect complement to Versico's Total Daylighting Solutions program, providing increased daylighting opportunities for a variety of applications. The SunPath TDD features a high-impact acrylic dome fused to an aluminum mounting ring that joins to a seamless aluminum flashing to provide unmatched strength and durability. The interior light tube utilizes an advanced reflection technology that provides superior light transmission and optimal interior daylighting.

### SunPath TDDs are ideal for use in:

- Warehouses with high inventory racks
- Classrooms that require convenient lighting control
- Roof systems with minimal truss or joist spacing
- Suspended- or hard-ceiling applications

### Light Performance

The SunPath high-performance tubular skylight brings natural light into almost any dark or unlit space. Daylight transmits through the clear top dome to a prismatic diffuser, which disperses the light evenly throughout the space. The chart below serves as a design guide to assist the specifier with approximating the number of TDDs required, based upon diameter size for a given square-foot area. The projections assume a ceiling height of 8–10 feet.

Model Diameter	Approximate Coverage Area	Approximate Light Output (lumens)
10"	150 ft <sup>2</sup>	Up to 3750
13"	250 ft <sup>2</sup>	Up to 6500
18"	400 ft <sup>2</sup>	Up to 11000
21"	500 ft <sup>2</sup>	Up to 13900
24"	600 ft <sup>2</sup>	Up to 16500

Figures produced under the right conditions. Time of day, season, length of tube and elbows will vary light output.

### Features and Benefits

- 100% impact-modified acrylic domes
- Unique rolled-lock aluminum retainer ring
- Seamless aluminum flashing (.080 GA Series 1100)
- Three diffuser options for even light distribution
- ENERGY STAR®-qualified for all climate zones
- 98% reflective Alanod Miro-SILVER® lining
- Eco-smart triple-glazed diffuser assembly (0.21 U-value/0.26 SHGC)
- Standard prismatic scatter disk insert within dome assembly
- Three dimmer system options (manual, switch-activated and IR remote)
- Seamless aluminum curb cap flashing (no painted steel or plastic)

## Alanod's Miro-SILVER Performance

The SunPath TDD light tube utilizes Miro-SILVER to create pure white light with no color shift during transmission, even after multiple reflections. At nearly 98% total light reflectivity, these Miro-SILVER light tubes allow daylight to illuminate interior spaces longer, and brighter, than any other TDD. Compared to polymer-laminated light tubes common in other TDDs, the SunPath's Miro-SILVER light tube will not experience a rapid decline in reflectivity after installation.

- Solid reflective material, NOT a laminated polymer sheet
- Will not delaminate, yellow, crack or peel due to prolonged UV exposure
- 25-year material warranty

### Reflector Material under different angles

Comparison between Miro-SILVER and Multi-layer Polymeric Film (MPF)

-  Advantage for Miro-SILVER (0-45°)
-  Some reflectivity for both products

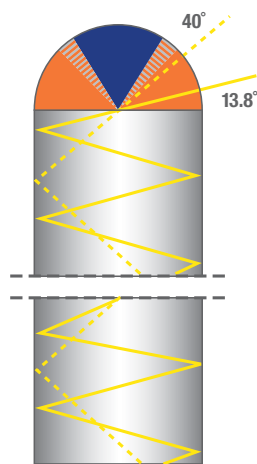

Miro-SILVER light pipes transmit much more light between 0 and 45° —when usable light is really needed.

Total Reflection is % Under an Angle of:

	13.8°	40°
Miro-SILVER	98.16	98.22
MPF	96.78	97.66

Tube 3 meters (10 ft) length x 300 mm (12 in) diameter

Angle 13.8°      Output      Miro-SILVER Advantage

Miro-SILVER	0.48	+78%
MPF	0.27	0%

Tube 3 meters (10 ft) length x 300 mm (12 in) diameter

Angle 40°      Output      Miro-SILVER Advantage

Miro-SILVER	0.82	+17%
MPF	0.70	0%

Number of Reflections		
13.8°	40 Reflections	78%
40.0°	11 Reflections	17%

### Reflectivity-Over-Time Test - Miro-SILVER vs. Multi-layer Polymeric Film

Comparison of sustained reflectivity after 150 hours UV-C Exposure

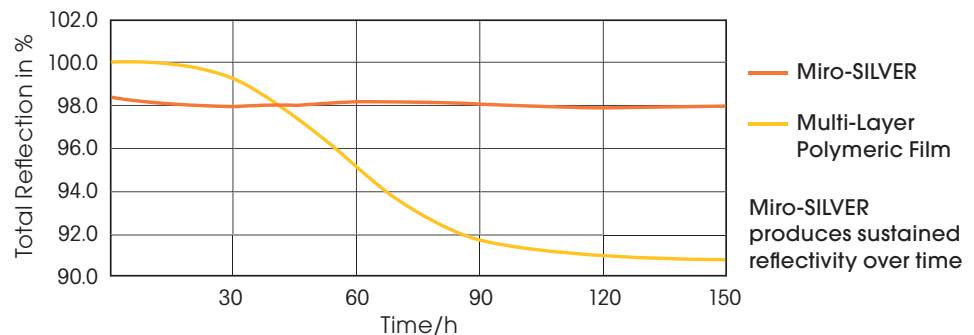

## System Components

SunPath Tubular Skylight kits consist of the following components:

- 1** Impact-Modified Acrylic Dome Assembly with Scatter Disk
- 2** Dust Seal
- 3** Left: .080 Seamless Curb Cap Flashing  
Right: Round Flat-Roof Aluminum Flashing Housing (pitched roof available)
- 4** Adjustable Elbow (0° - 45° depending on size)
- 5** 98% Reflective Light Tube (24" Long)
- 6** Aluminum Trim Ring
- 7** Double Glaze Light Diffuser
- 8** Ceiling Decorative Ring (Industrial Kit Diffuser attaches directly to light tube when no ceiling exists)
- 9** 2' x 2' Round-to-Square Transition Sleeve with Diffuser (21" only) for Suspended Ceilings (Type B Kits Available with Standard Round Diffuser Assemblies)
- 10** Hardware Kit

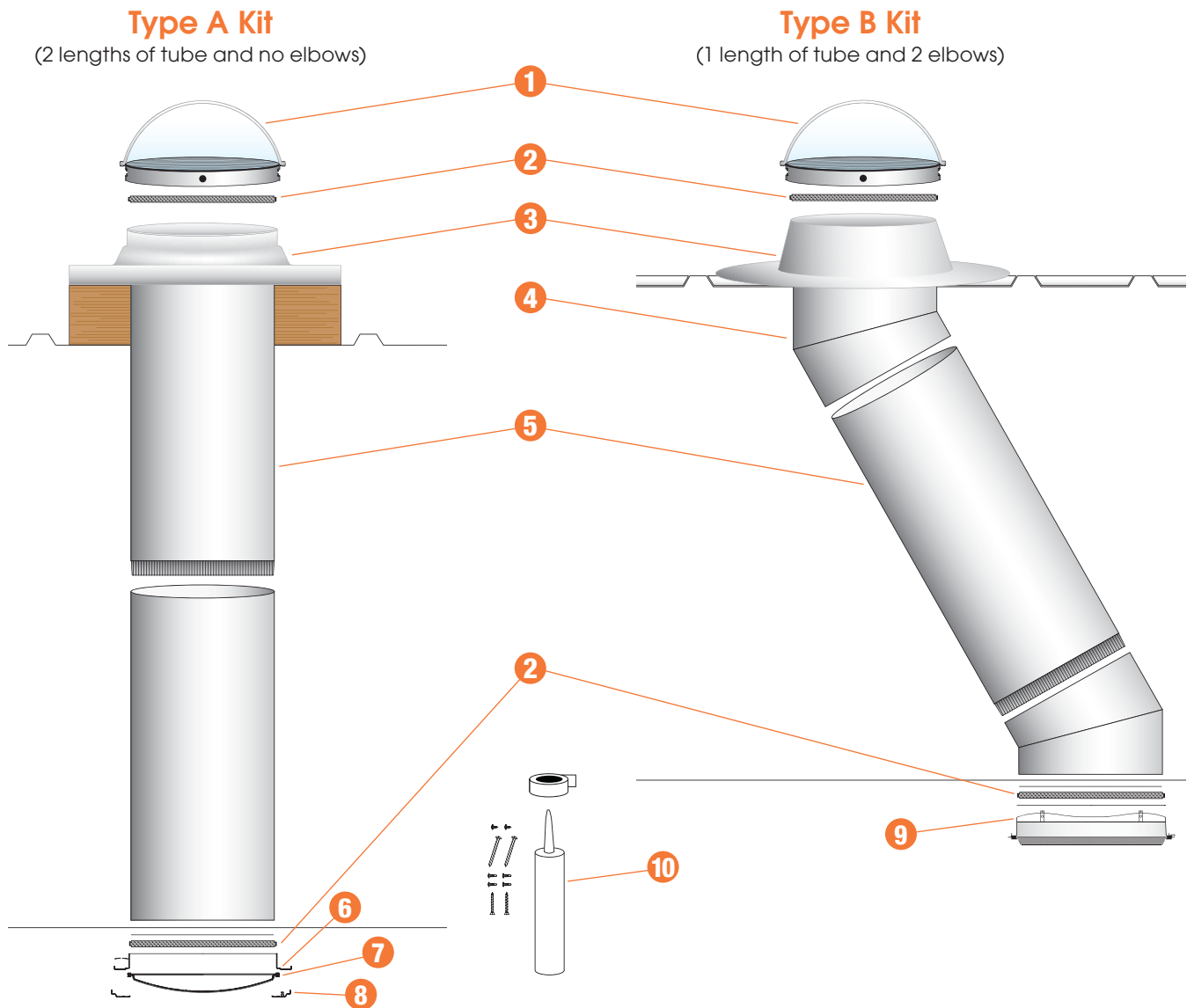



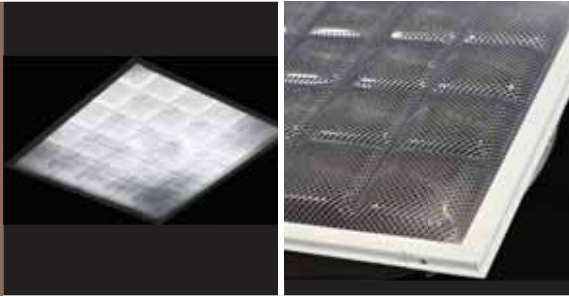

## Max Glow Diffuser Option



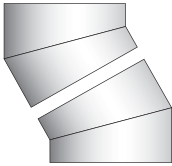

## Flashing Sleeve

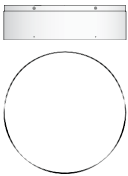

## System Accessories

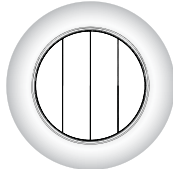
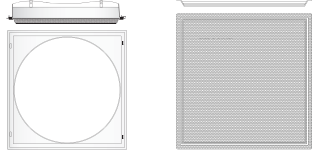
Product	Description
 <b>24" Light Tube</b>	24"-long tubes utilize Alanod Miro-SILVER for high reflectivity and long-term UV resistance.
 <b>Set of 2 Elbows</b>	14"-long elbows allow easy routing around obstructions 0-45° adjustment, depending on size.
 <b>Round Flashing Housing</b>	Manufactured from .080 GA Aluminum, this housing comes standard 6" or 9" for flat-roof applications. Pitched-roof flashings are available.
 <b>3" Flashing Extension</b>	This component attaches to round flashing housing when additional height above the roof deck is required (3" increments).
 <b>Cap Flashing</b>	Used on a flat roof with a site-built or pre-manufactured metal curb. Manufactured from .080 Series 1100 aluminum.

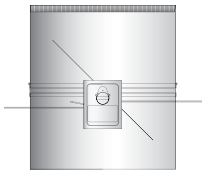
Product	Description
 <b>Security Bar</b>	Three aluminum bars welded into a perimeter ring. Inserts into flashing turret.
 <b>Office Kit - Suspended Ceilings</b> <b>Prismatic Diffuser</b>	This 2' x 2' round-to-square transition piece snaps into the metal ceiling grid. Several diffuser options are available to insert into frame.
 <b>Trim Ring - Hard Ceiling</b>	This white powder-coated aluminum ring provides a finished appearance to the installation.
 <b>Trim Ring - Open Ceiling</b>	A highly polished aluminum retainer ring attaches the diffuser directly to the light tube and is packaged with the Industrial Kit.
 <b>Dimmer System</b>	Three options: <ul style="list-style-type: none"> <li>• Manual</li> <li>• Switch-activated with synchronization capability</li> <li>• IR remote - full control of damper rotation</li> </ul>

## Typical Specification

- Dome Assembly** Vacuum-formed, .220"-thick, 100% high-impact clear acrylic dome with UV stabilization, CC2 light-transmitting plastic material, non-yellowing. Mounted and sealed to .080"-thick, 1100-0 aluminum dome ring. Engineered to eliminate heat and moisture.
- Light Scatter** .110"-thick, 100% high-impact acrylic prismatic disk with UV stabilization inserts into dome assembly to minimize heat transfer.
- Dust Seal** Used between dome ring and flashing, between flashing and light tube and between light tube and transition box. Polypropylene weather-strip pile with 3M™ adhesive backing to prevent bug, dirt and air infiltration.
- Roof Flashing** One-piece, seamless, .080"-thick 1100-0 aluminum flashing.
- Flat** – 4", 6", 8", 9" and 11" height with 4"-wide base to seal securely onto roof.
- Pitched** – for 3/12-pitched roofs; can be used on higher pitch roofs with elbows.
- Curb** – Inside dimensions are 27" x 27"
- Light Tube** Anodized aluminum Miro 27 SILVER, .020"-thick, 98% reflectivity, resistant to moisture, corrosion and extreme temperatures.
- Type A standard kit includes:**  
Two 24" tubes
- Type B kit includes:**  
One 24" tube and two 14" elbows

### Optical Properties of Miro 27 SILVER

Total Light Reflection	(\$1)(%)	≥ 98	DIN 5036-3 (U-Globe)
Total Light Reflection	(\$1)(%)	≥ 98	ASTM E1651 (TR-2)
Diffuse Light Reflection	(\$1)(%)	< 6	DIN 5036-3 (U-Globe)
Solar Reflection	(\$1)(%)	95	DIN EN 410
Brightness	along: ( )	93	ISO 7768
	across: ( )	92	(60°/calibrated 91.8)
Brightness	Image Clarity ( ) Diffuseness ( )	≥ 97	ASTM E430
		0.00	(Hunter Dorigon) ASTM E430 (Hunter Dorigon)
Color Values	b*( )	0 b* +5	DIN 5033-4 10°

Standard	Title of Test	Results
NFRC 100-2004	U Factor (Standard Done Assembly) (Eco-Smart Assembly)	0.46
		0.21
NFRC 200-2004	Solar Heat Gain Coefficient (Standard) (Eco-Smart Assembly)	0.33
		0.26

The SunPath TDD was evaluated in full compliance with NFRC (National Fenestration Rating Council) requirements for U-Factor and Solar Heat Gain Coefficient to the standards listed to the left.

## Condensational Control

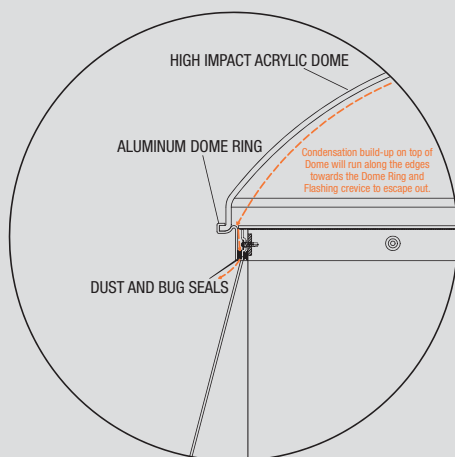

## Eco-Smart Diffuser System

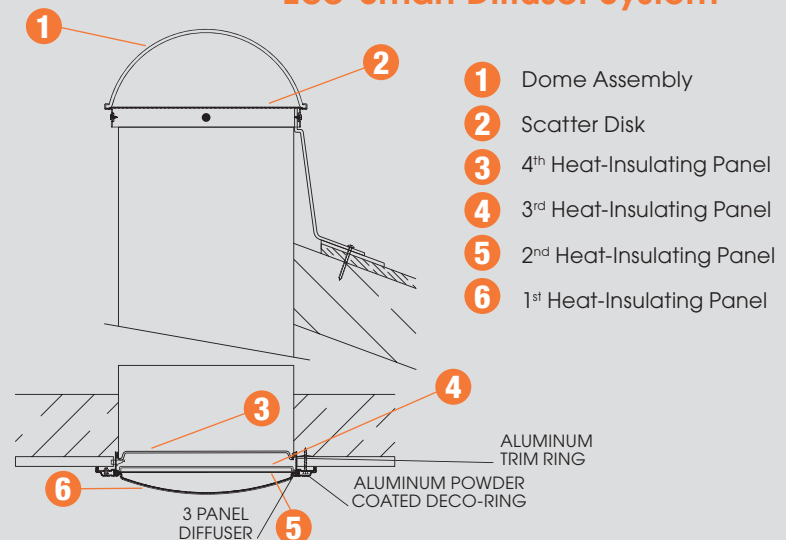

## Ordering Requirements/Checklist

- Diameter:**  10"  13"  18"  21"  24" (13" and 21" standard, all others are special order)
- Flat Roof:**  Yes  No
- Type of Ceiling:**  Open  Suspended  Hard
- Length of Run** (Distance from roof deck to ceiling +12") \_\_\_\_\_feet
- Straight Run or Elbows Required:**  Type A (no elbows)  Type B (with a set of 2 elbows)
- Type of Flashing:**  Round  Curb Cap Flashing (fits on field-fabricated square curb)
- Type of Diffuser:**  Prismatic  Opal  Max Glow
- Accessories:**  3" Flashing Extenders  Dimmer Systems (manual/switch controlled/IR remote)  
 One-Piece Flashing Sleeves  Electric Light Kits  
 Security Bar Kits  Eco-Smart Model

### Wireless Dimmer



### Electric Light Kit



### Curb Cap Flashing

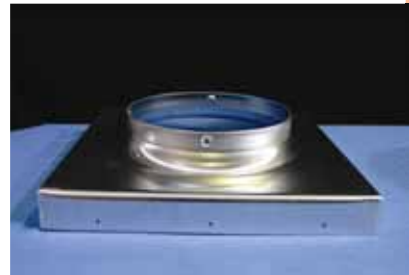

### 3" Flashing Extender



### Security Bar Kit



## SunPath Warranty

Versico warrants against manufacturing defects, corrosion, rust, deterioration, fading and breakage on all components for a 10-year period of time from the date of purchase.

This warranty is subject to proper installation of the unit in accordance with the manufacturer's written installation instructions. This warranty does not apply where repairs or alterations have been made or attempted by others, or the unit has been abused and/or misused.

Before



400 Watt Metal Halides



21" SunPath Industrial Kits



## SunPath vs. Competitor

Feature	SunPath	Competitor
Dome	100% Impact Modified Acrylic .220"-thick CC2 Material	Type DA Acrylic .143"-thick CC2 Material
Flashing	.080 Aluminum 1100 Series	Stamped Painted Steel (.028"-thick) or Plastic
Dome Attachment	Unique Aluminum Retainer Ring	Through Dome (Stress Point)
Light Tubes	98% Reflective 24"-Long Less Seams	Claim 99% Reflective 16"-Long
UV Degradation After 150 Hours	< 1%	> 7%
Elbows	Yes	Yes
Flashing Designs: Pitched Roof	Yes	Yes
Flashing Designs: Flat Roof	Yes	Yes
Flashing Designs: Curb Mount	Yes	Yes
Diffusers: Flat, Dual-Glazed	Yes	Yes
Diffusers: Convex, Dual-Glazed	Yes	Yes
Diffuser Trim Ring	Powder-Coated Aluminum	Plastic
Design and Layout Support	Free	Do-it-Yourself Guidelines
Parent Company	USA	Australia
ENERGY STAR Model	Yes	Yes
ICC Approval	Yes	Yes
NFRC Approval	Yes	Yes
Office Kit with 2' x 2' diffuser	Yes	Yes
Fresnel Lens	Alternate-MaxGlow (Dual-Glazed)	Yes (NOT Dual-Glazed)
Electric Light Kit (1 and 2 bulb)	Yes	Yes
Bath Exhaust Fan	Yes	Yes
Tube Sizes	10", 13", 18", 21" and 24"	10", 14" and 21"
Warranty	Total Roof System Warranty	Material Only
Dimmer	Electric, IR Remote, and Manual	Electric Only

## Bottom Line

Why not specify a Versico SunPath TDD and get the proven support, performance and warranty from the Versico Representative that you know and trust?



A SINGLE SOURCE FOR SINGLE-PLY ROOFING

Versico, PO Box 1289, Carlisle, PA 17013  
Tel: **800.992.7663** Fax: 717.960.4036 Web: **www.versico.com**